

# 38535

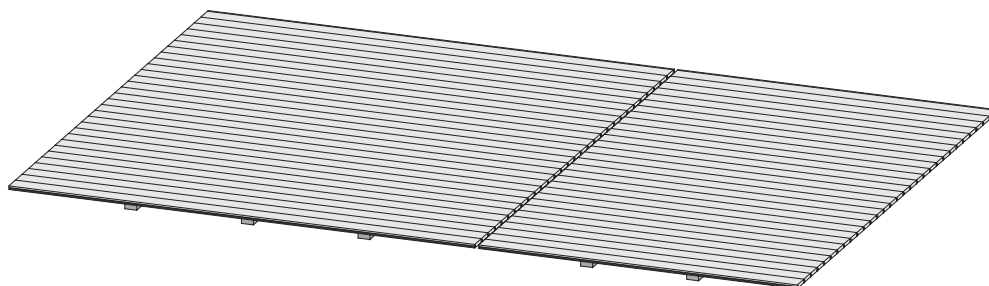

-  **Aufbauanleitung**
-  **Building Instructions**
-  **notice de montage**
-  **montagehandleiding**
-  **Montagevejledning**
-  **Instrucciones de construcción**
-  **Istruzioni per il montaggio**
-  **Montážní návod**
-  **Navodila za sestavljanje**

Bitte bewahren Sie die Anleitung und den Garantieschein zur Seriennummer auf.

Vernichten Sie diese erst nach Ablauf der Garantiezeit.

Eventuelle Beanstandungen können mithilfe der Stückliste einfacher zugeordnet werden.

#### Beigelegte Dokumente

- Informationsheft
- Garantieschein zur Seriennummer
- Typenschild inkl. Warnhinweise (Sauna)
- ggf. Zubehör-Anleitungen in externen Paketen

#### \*

 Nicht im Lieferumfang enthalten

 Not included

 Non comprises dans la livraison

 Niet bijgeleverd

 No forman parte del suministro

 Non incluso

 V ceně není zahrnuto

 Ikke inkluderet

 Ni vključeno v obseg dobave

#### 2

 Nicht gebraucht

 Not needed

 Pas nécessaire

 Niet nodig

 No es necesario

 Non necessario

 Není nutná

 Ikke nødvendigt

 Ne uporablja se

#### 4

 Fixiert vorübergehend

 Fixed temporarily

 Temporairement fixe

 Tijdelijk vast

 Temporalmente fijo

 Temporaneamente fisso

 Dočasně pevný

 Midlertidigt rettet

 Začasno popravi

#### 1

 Länge muss ermittelt und zugesägt werden

 Length must be determined and sawn

 La longueur doit être déterminée et sciée

 De lengte moet worden bepaald en worden gezaagd

 La longitud debe ser determinada y aserrada

 La lunghezza deve essere determinata e segata

 Délka musí být určena a rozřezána

 Længden skal bestemmes og saves

 Določiti je treba dolžino in jo odrezati po velikosti.

#### 3

 Mit Zubehör

 With accessories

 Avec accessoires

 Met toebehoren

 Con accesorios

 Con accessori

 S příslušenstvím

 Med tilbehør

 Z dodatki

#### 5

 Bestand vom Haus

 Inventory of the house

 Inventaire de la maison

 Inventaris van het huis

 Inventario de la casa

 Inventario della casa

 Inventář domu

 Inventar af huset

 Inventarizacija hiše

 Vergleichen Sie zuerst die Material-liste mit Ihrem Paketinhalt! Bitte haben Sie Verständnis, dass Beanstandungen nur im nicht aufgebauten Zustand bearbeitet werden können!

 First compare the list of materials with your package contents! Please understand that complaints can be processed in the non-built status only!

 Commencez par comparer la liste du matériel avec le contenu de votre paquet! Sachez que nous traitons uniquement les réclamations concernant le matériel à l'état non monté!

 Vergelijk eerst de lijst van materialen met de inhoud van uw pakket! Reclamaties kunnen alleen in behandeling worden genomen zolang de onderdelen nog niet zijn gemonteerd!

 Start med at kontrollere materialelisten med indholdet af den leverede pakke! Vi gør venligst opmærksom på at reklamationer kun kan behandles for materialer som ikke er blevet bearbejdet!

 En primer lugar, compare la lista de material con el contenido del paquete. Rogamos entienda que las reclamaciones sólo pueden ser tramitadas antes de montar el objeto!

 Confrontate questa distinta materiali prima con il contenuto del pacchetto! Vi preghiamo di comprendere che eventuali reclami possono essere accolti solo prima del montaggio!

 Nejprve přezkontrolujte obsah balení podle materiálového listu! Mějte pochopení pro to, že případnou reklamaci se můžeme zabývat pouze tehdy, když díly nebudou smontované! Za pomoci tohoto seznamu můžete jednotlivé díly přiřadit k montážnímu návodu.

 Najprej primerajte zoznam materialov z vsebino vašega paketa! Upoštevajte, da lahko pritožbe obravnavamo le v nesestavljenem stanju!

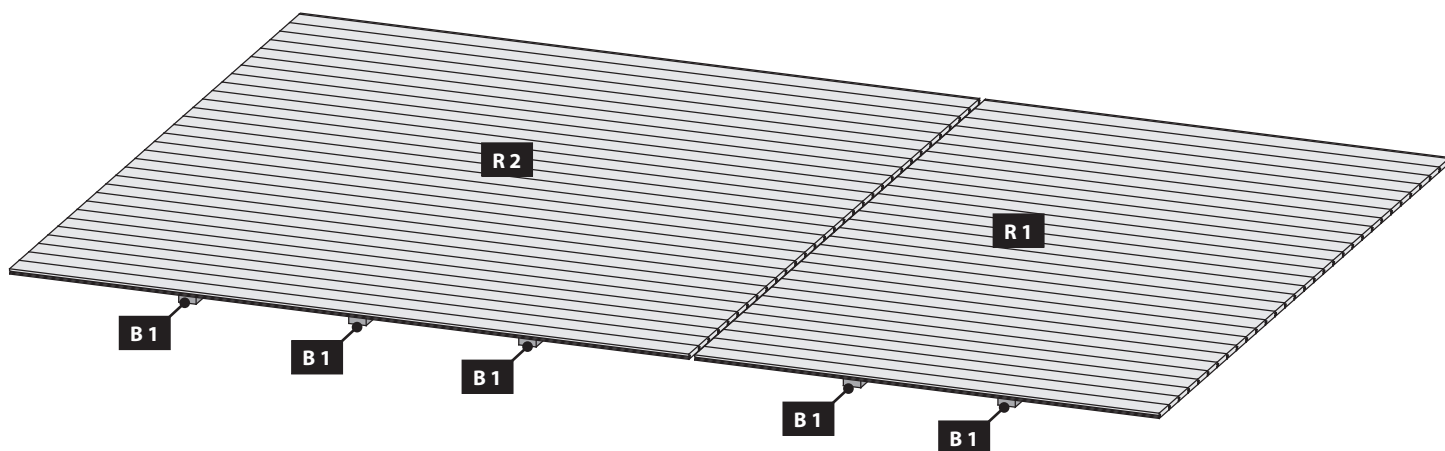
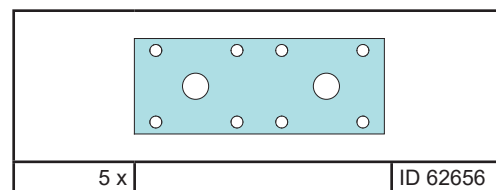
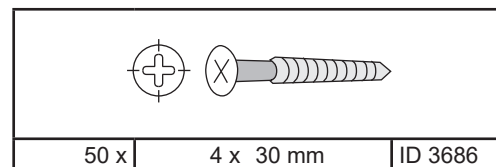
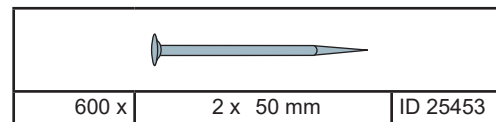
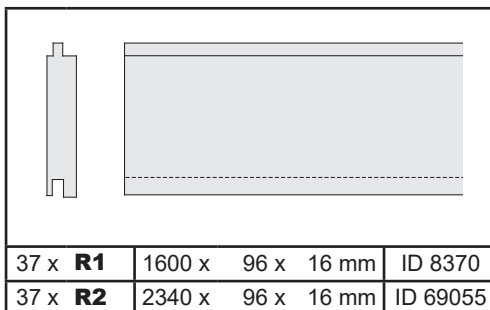
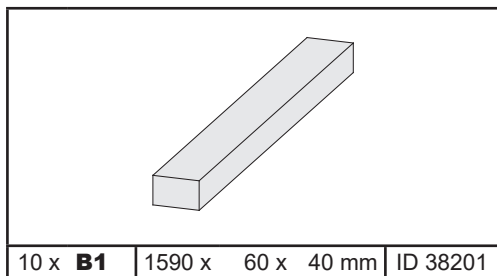

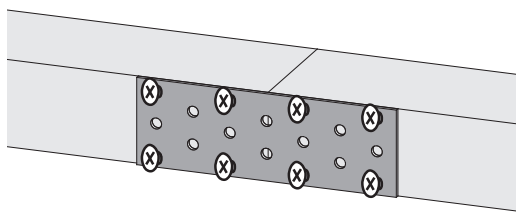

40x  
Ø3 mm 4x30

A 4x30 drill bit with a diameter of 3 mm.

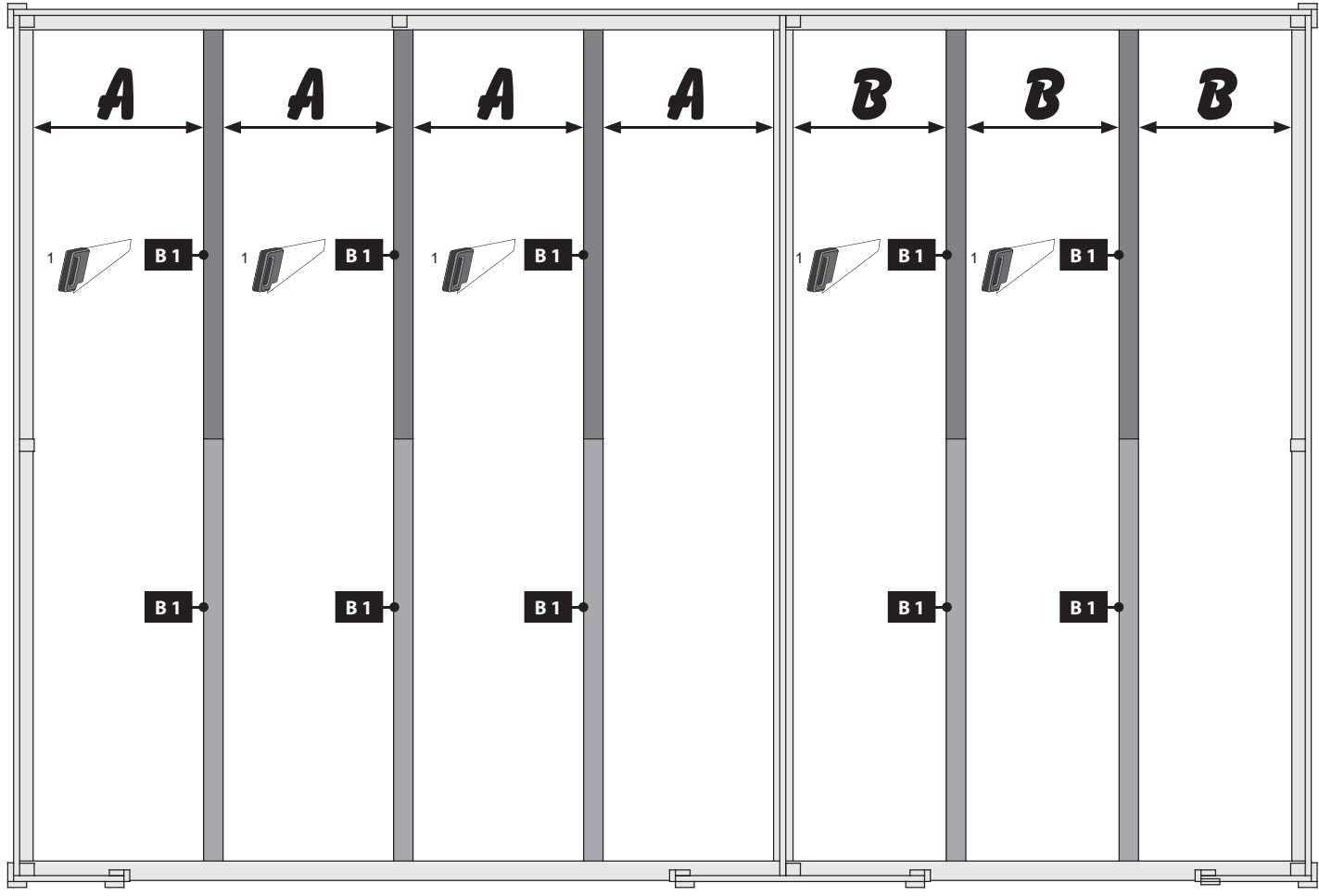
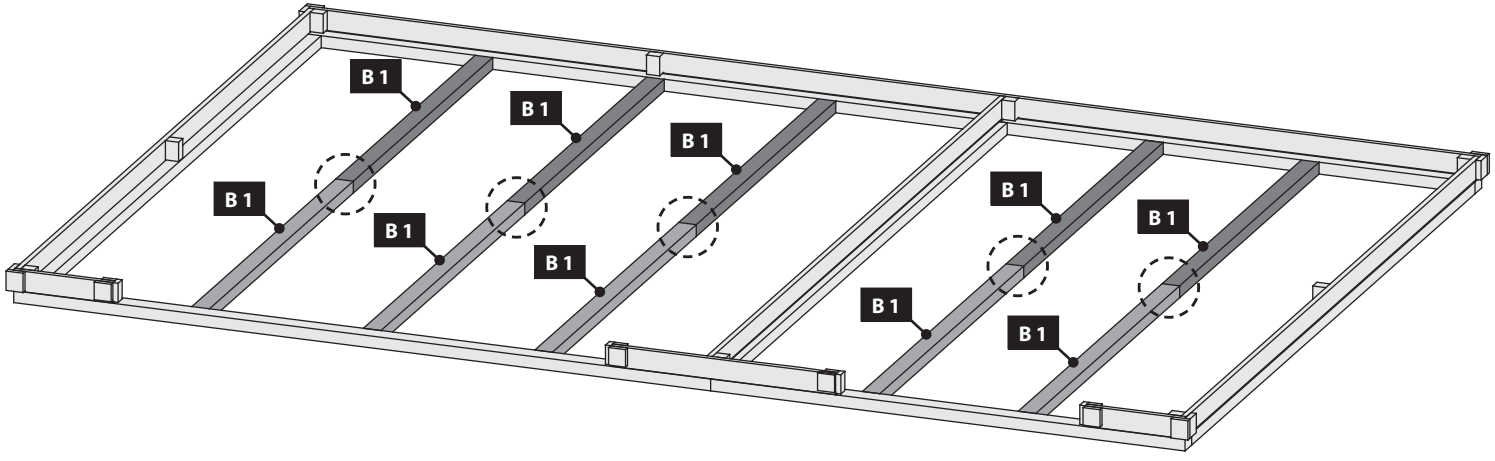

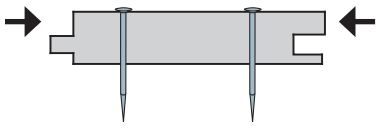



 Breite Seite nach oben

 Width side up

 Largeur vers le haut

 Bred side opad

 Breedte side up

 Ancho de banda de hasta

 Larghezza verso l'alto

 Šířka stranou nahoru

 Široka stran navzgor

02

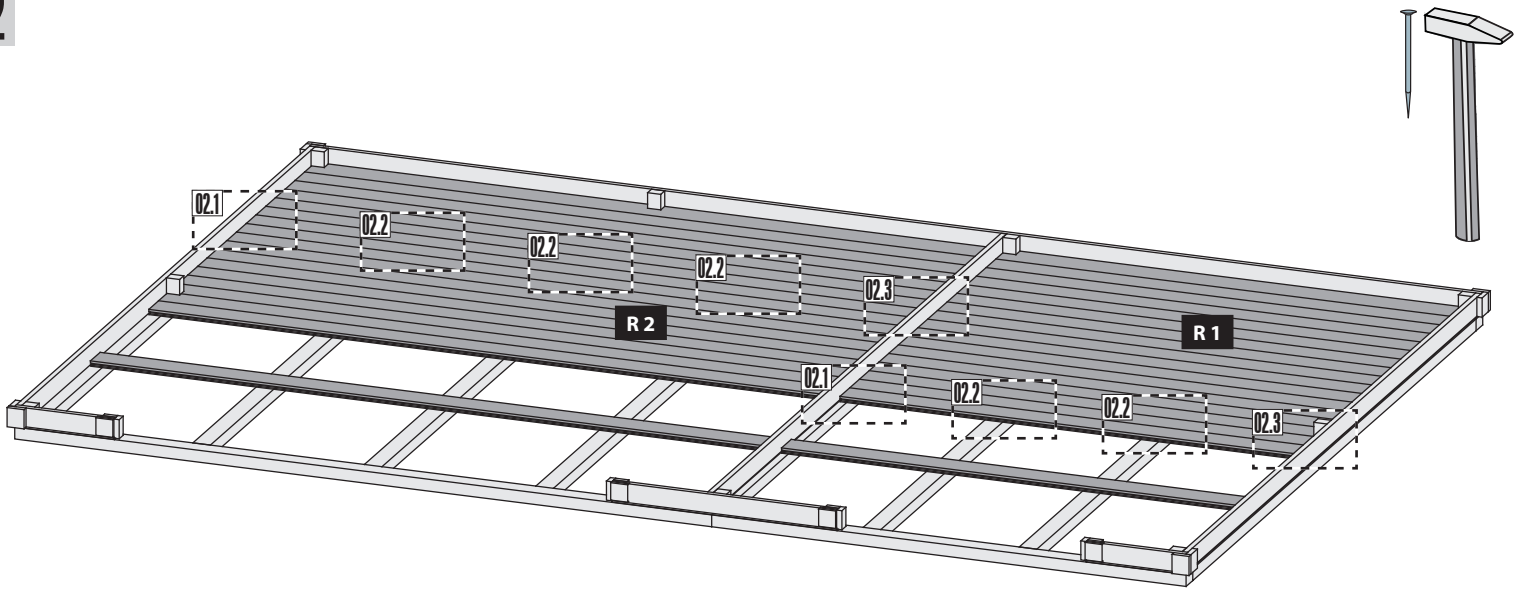

02.1

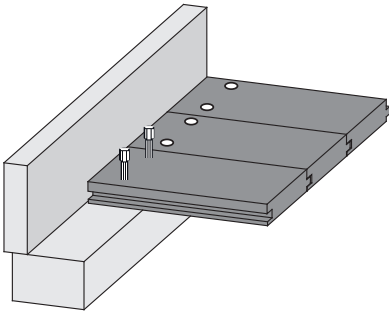

02.2

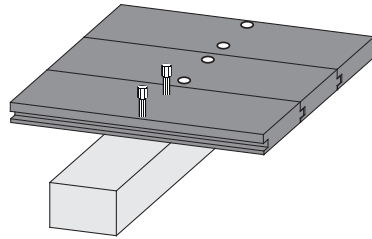

02.3

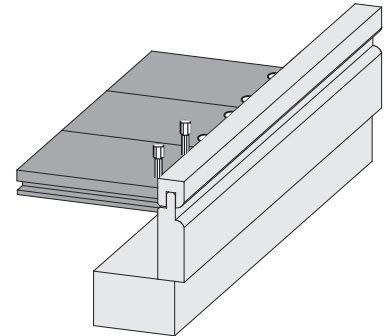

03

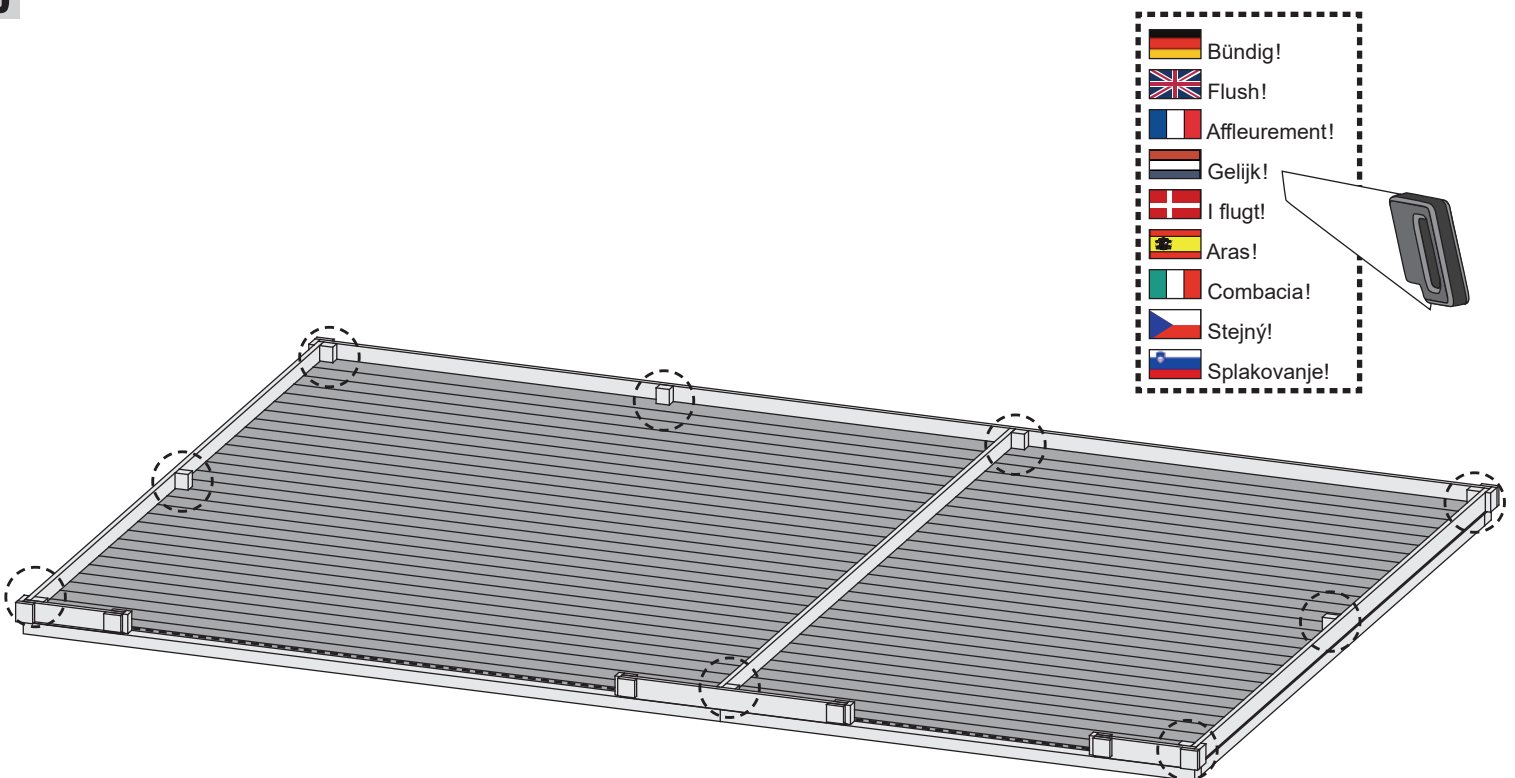

-  Bündig!
-  Flush!
-  Affleurement!
-  Gelijk!
-  I flugt!
-  Aras!
-  Combacia!
-  Stejný!
-  Splakovanje!

